

SL185034-A INA

SKU: INASL185034-A

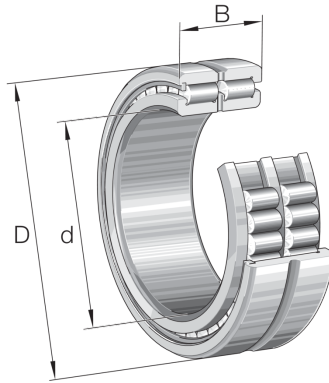

Extra afbeelding



Specificaties

designation	SL185034-A
Boring diameter (mm)	170
Buitendiameter (mm)	260
Breedte (mm)	122
Gewicht (kg)	22.5
Omschrijving (EN)	Cylindrical roller bearing SL185..-A, full complement roller set, two-row, semi-locating bearing, 1 rib on outer ring, 3 ribs on inner ring, type SL18
EAN-code	4054365602672
Merk	INA
Boring diameter (mm)	170
Buitendiameter (mm)	260
Breedte (mm)	122
Gewicht (kg)	22.5

Beschrijving

SL185034-A INA

Product URL

<https://aandrijftechniek.nl/product/sl185034-a-ina/>