

## SL185012-A INA

SKU: INASL185012-A

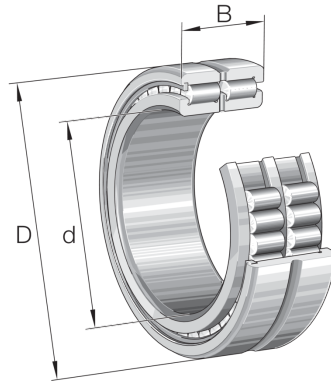

### Extra afbeelding



### Specificaties

<b>designation</b>	SL185012-A
<b>Boring diameter (mm)</b>	60
<b>Buitendiameter (mm)</b>	95
<b>Breedte (mm)</b>	46
<b>Gewicht (kg)</b>	1.19
<b>Omschrijving (EN)</b>	Cylindrical roller bearing SL185..-A, full complement roller set, two-row, semi-locating bearing, 1 rib on outer ring, 3 ribs on inner ring, type SL18
<b>EAN-code</b>	4012802699463
<b>Merk</b>	INA
<b>Boring diameter (mm)</b>	60
<b>Buitendiameter (mm)</b>	95
<b>Breedte (mm)</b>	46
<b>Gewicht (kg)</b>	1.19

# Beschrijving

SL185012-A INA

## Product URL

<https://aandrijftechniek.nl/product/sl185012-a-ina/>