

SL185007-A INA

SKU: INASL185007-A

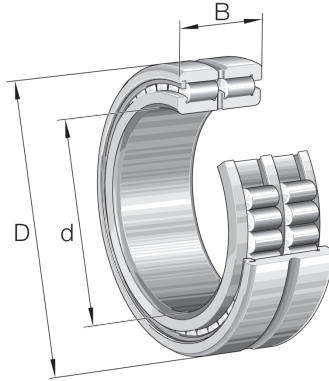

Specificaties

designation	SL185007-A
Boring diameter (mm)	35
Buitendiameter (mm)	62
Breedte (mm)	36
Gewicht (kg)	0.4391
Omschrijving (EN)	Cylindrical roller bearing SL185..-A, full complement roller set, two-row, semi-locating bearing, 1 rib on outer ring, 3 ribs on inner ring, type SL18
EAN-code	4012802425109
Merk	INA
Boring diameter (mm)	35
Buitendiameter (mm)	62
Breedte (mm)	36
Gewicht (kg)	0.4391

Beschrijving

SL185007-A INA

Product URL

<https://aandrijftechniek.nl/product/sl185007-a-ina/>