

## SL184944-A INA

SKU: INASL184944-A

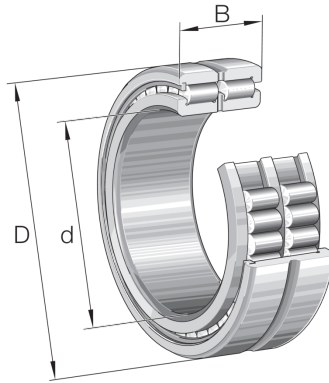

### Specificaties

<b>designation</b>	SL184944-A
<b>Boring diameter (mm)</b>	220
<b>Buitendiameter (mm)</b>	300
<b>Breedte (mm)</b>	80
<b>Gewicht (kg)</b>	17.2
<b>Omschrijving (EN)</b>	Cylindrical roller bearing SL18..-A, full complement roller set, two-row, semi-locating bearing, 1 rib on outer ring, 3 ribs on inner ring, type SL18
<b>EAN-code</b>	4054364130473
<b>Merk</b>	INA
<b>Boring diameter (mm)</b>	220
<b>Buitendiameter (mm)</b>	300
<b>Breedte (mm)</b>	80
<b>Gewicht (kg)</b>	17.2

### Beschrijving

SL184944-A INA

## Product URL

<https://aandrijftechniek.nl/product/sl184944-a-ina/>