

## SL014918-A INA

SKU: INASL014918-A

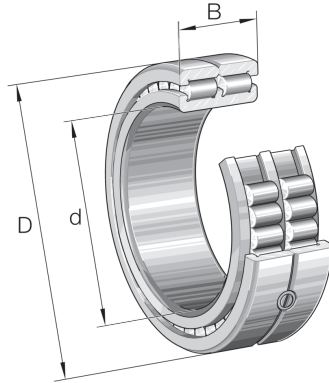

### Specificaties

<b>designation</b>	SL014918-A
<b>Boring diameter (mm)</b>	90
<b>Buitendiameter (mm)</b>	125
<b>Breedte (mm)</b>	35
<b>Gewicht (kg)</b>	1.312
<b>Omschrijving (EN)</b>	Cylindrical roller bearings SL149, locating bearing, double row, full complement cylindrical roller set, dimension series 49
<b>EAN-code</b>	4054364122768
<b>Merk</b>	INA
<b>Boring diameter (mm)</b>	90
<b>Buitendiameter (mm)</b>	125
<b>Breedte (mm)</b>	35
<b>Gewicht (kg)</b>	1.312

### Beschrijving

SL014918-A INA

## Product URL

<https://aandrijftechniek.nl/product/sl014918-a-ina/>