

RSAO30-XL INA

SKU: INARSAO30

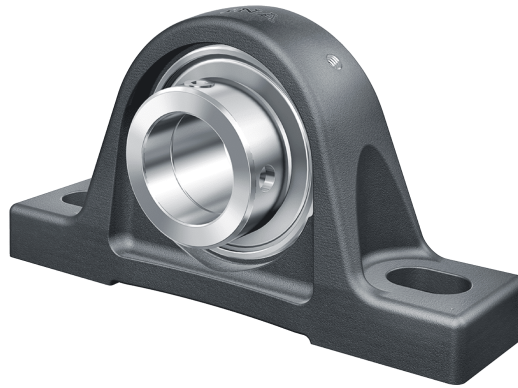

Specificaties

designation	RSAO30-XL
Boring diameter (mm)	30
Buitendiameter (mm)	180
Breedte (mm)	95
Gewicht (kg)	1.86
Omschrijving (EN)	Plummer block housing units RSAO, cast iron housing, radial insert ball bearing with eccentric locking collar, R seals
EAN-code	4012802803419
Merk	INA
Boring diameter (mm)	30
Buitendiameter (mm)	180
Breedte (mm)	95
Gewicht (kg)	1.86

Beschrijving

RSAO30-XL INA Pillow blocks

Product URL

<https://aandrijftechniek.nl/product/rsao30-xl-ina/>