

## PASEY60-XL-N INA

SKU: INAPASEY60-N

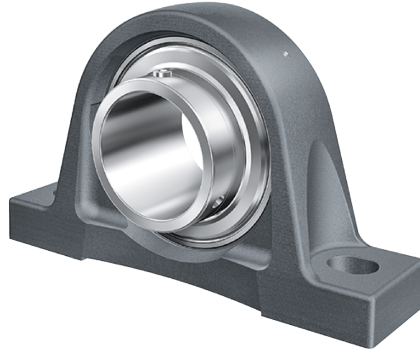

### Extra afbeelding



### Specificaties

<b>designation</b>	PASEY60-XL-N
<b>Boring diameter (mm)</b>	60
<b>Buitendiameter (mm)</b>	240
<b>Breedte (mm)</b>	140
<b>Gewicht (kg)</b>	4.13
<b>Omschrijving (EN)</b>	Plummer block housing units PASEY, cast iron housing, radial insert ball bearing with grub screws in inner ring, P seals
<b>EAN-code</b>	4054372845215
<b>Merk</b>	INA
<b>category1</b>	Ball bearing units
<b>endCategory</b>	Pillow blocks
<b>Boring diameter (mm)</b>	60
<b>Buitendiameter (mm)</b>	240
<b>Breedte (mm)</b>	140

<b>Gewicht (kg)</b>	4.13
---------------------	------

## Beschrijving

PASEY60-XL-N INA Pillow blocks

## Product URL

<https://aandrijftechniek.nl/product/pasey60-xl-n-ina/>