

PASE40-XL-N INA

SKU: INAPASE40-N

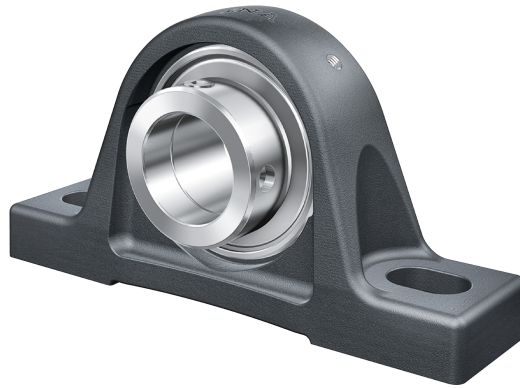

Extra afbeelding



Specificaties

designation	PASE40-XL-N
Boring diameter (mm)	40
Buitendiameter (mm)	179
Breedte (mm)	99
Gewicht (kg)	1.84
Omschrijving (EN)	Plummer block housing units PASE, cast iron housing, radial insert ball bearing with eccentric locking collar, P seals
EAN-code	4054372301728
Merk	INA
category1	Ball bearing units
endCategory	Pillow blocks
Boring diameter (mm)	40
Buitendiameter (mm)	179
Breedte (mm)	99

Gewicht (kg)	1.84
---------------------	------

Beschrijving

PASE40-XL-N INA Pillow blocks

Product URL

<https://aandrijftechniek.nl/product/pase40-xl-n-ina/>