

## PASE35-XL-N INA

SKU: INAPASE35-N

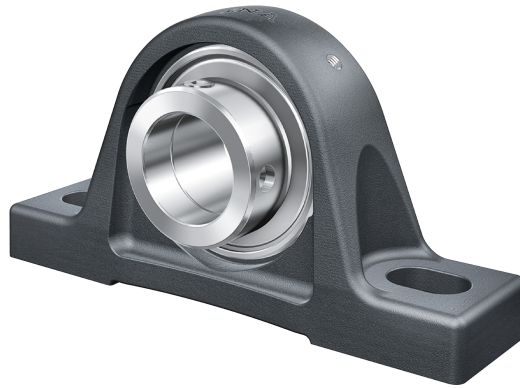

### Extra afbeelding



### Specificaties

<b>designation</b>	PASE35-XL-N
<b>Boring diameter (mm)</b>	35
<b>Buitendiameter (mm)</b>	163
<b>Breedte (mm)</b>	93
<b>Gewicht (kg)</b>	1.57
<b>Omschrijving (EN)</b>	Plummer block housing units PASE, cast iron housing, radial insert ball bearing with eccentric locking collar, P seals
<b>EAN-code</b>	4054372301926
<b>Merk</b>	INA
<b>category1</b>	Ball bearing units
<b>endCategory</b>	Pillow blocks
<b>Boring diameter (mm)</b>	35
<b>Buitendiameter (mm)</b>	163
<b>Breedte (mm)</b>	93

<b>Gewicht (kg)</b>	1.57
---------------------	------

## Beschrijving

PASE35-XL-N INA Pillow blocks

## Product URL

<https://aandrijftechniek.nl/product/pase35-xl-n-ina/>