

NA6905-XL-C3 INA

SKU: INANA6905-XL-C3

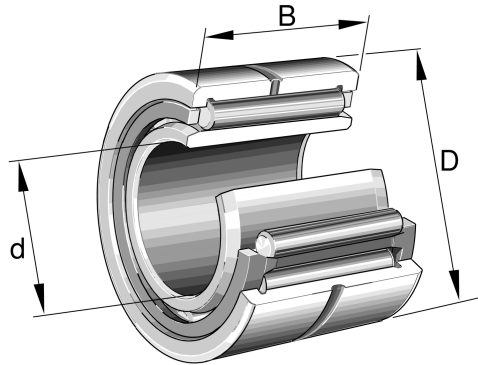

Extra afbeelding



Specificaties

designation	NA6905-XL-C3
Boring diameter (mm)	25
Buitendiameter (mm)	42
Breedte (mm)	30
Gewicht (kg)	0.159
Omschrijving (EN)	Needle roller bearing NA69..-XL, single row, with inner ring, outer ring with 2 bords
EAN-code	4012802702736
Merk	INA
Boring diameter (mm)	25
Buitendiameter (mm)	42
Breedte (mm)	30
Gewicht (kg)	0.159

Beschrijving

NA6905-XL-C3 INA Needle roller bearings with machined rings with flanges, with an inner ring

Product URL

<https://aandrijftechniek.nl/product/na6905-xl-c3-ina/>