

NA4910-XL-C3 INA

SKU: INANA4910-XL-C3

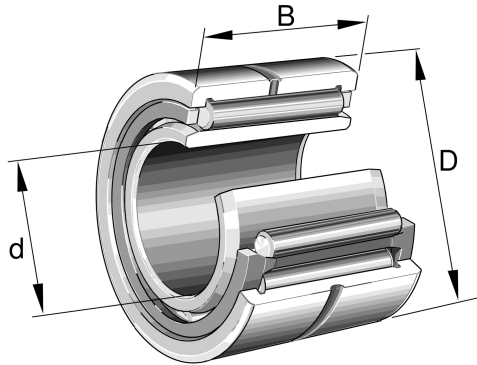

Extra afbeelding



Specificaties

designation	NA4910-XL-C3
Boring diameter (mm)	50
Buitendiameter (mm)	72
Breedte (mm)	22
Gewicht (kg)	0.278
Omschrijving (EN)	Needle roller bearing NA49..-XL, single row, with inner ring, outer ring with 2 bords
EAN-code	4012802702637
Merk	INA
Boring diameter (mm)	50
Buitendiameter (mm)	72
Breedte (mm)	22
Gewicht (kg)	0.278

Beschrijving

NA4910-XL-C3 INA Needle roller bearings with machined rings with flanges, with an inner ring

Product URL

<https://aandrijftechniek.nl/product/na4910-xl-c3-ina/>