

NA4903-XL-C3 INA

SKU: INANA4903-XL-C3

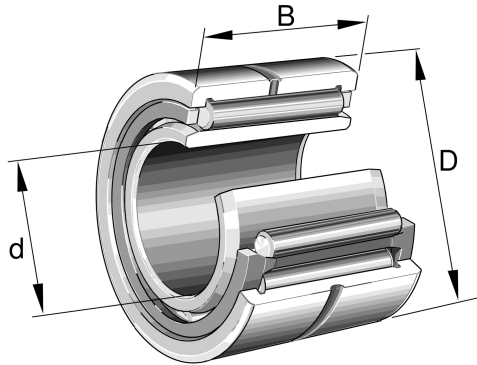

Extra afbeelding



Specificaties

designation	NA4903-XL-C3
Boring diameter (mm)	17
Breedte (mm)	30
Gewicht (kg)	0.0385
Omschrijving (EN)	Radial roller bearing NA..-XL
EAN-code	4012802702231
Merk	INA
Boring diameter (mm)	17
Breedte (mm)	30
Gewicht (kg)	0.0385

Beschrijving

NA4903-XL-C3 INA Needle roller bearings with machined rings with flanges, with an inner ring

Product URL

<https://aandrijftechniek.nl/product/na4903-xl-c3-ina/>