

NA4824-XL-C3 INA

SKU: INANA4824-C3

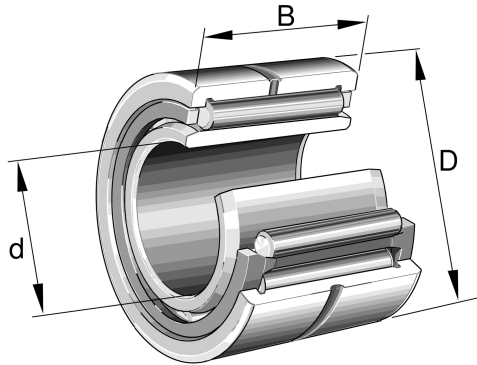

Extra afbeelding



Specificaties

designation	NA4824-XL-C3
Boring diameter (mm)	120
Buitendiameter (mm)	150
Breedte (mm)	30
Gewicht (kg)	1.16
Omschrijving (EN)	Needle roller bearing NA..-XL, single row, with inner ring, outer ring with 2 bords
EAN-code	4054363037360
Merk	INA
Boring diameter (mm)	120
Buitendiameter (mm)	150
Breedte (mm)	30
Gewicht (kg)	1.16

Beschrijving

NA4824-XL-C3 INA Needle roller bearings with machined rings with flanges, with an inner ring

Product URL

<https://aandrijftechniek.nl/product/na4824-xl-c3-ina/>