

LR204-2RSR INA

SKU: INALR204-2RSR

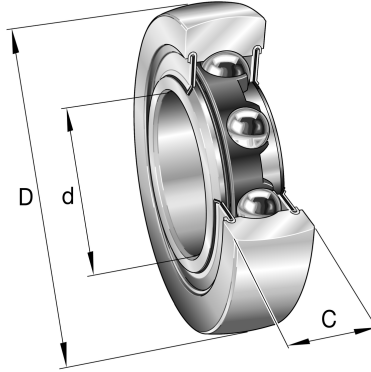

Extra afbeelding



Specificaties

designation	LR204-2RSR
Boring diameter (mm)	52
Buitendiameter (mm)	20
Breedte (mm)	14
Gewicht (kg)	0.15
Omschrijving (EN)	Track roller LR..-2RSR, single row, no plastic tyre
EAN-code	4012802825145
Merk	INA
Boring diameter (mm)	52
Buitendiameter (mm)	20
Breedte (mm)	14
Gewicht (kg)	0.15

Beschrijving

LR204-2RSR INA

Product URL

<https://aandrijftechniek.nl/product/lr204-2rsr-ina/>