

LR203-2RSR INA

SKU: INALR203-2RSR

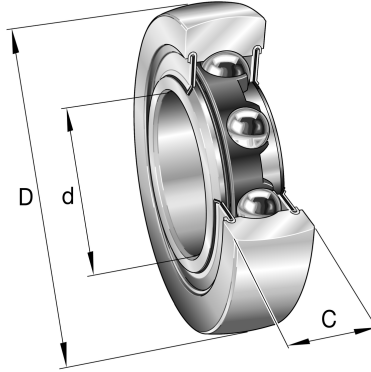

Extra afbeelding



Specificaties

designation	LR203-2RSR
Boring diameter (mm)	47
Buitendiameter (mm)	17
Breedte (mm)	12
Gewicht (kg)	0.11
Omschrijving (EN)	Track roller LR..-2RSR, single row, no plastic tyre
EAN-code	4012802826159
Merk	INA
Boring diameter (mm)	47
Buitendiameter (mm)	17
Breedte (mm)	12
Gewicht (kg)	0.11

Beschrijving

LR203-2RSR INA

Product URL

<https://aandrijftechniek.nl/product/lr203-2rsr-ina/>