

LR202-2RSR INA

SKU: INALR202-2RSR

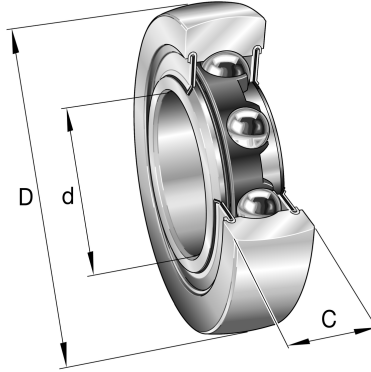

Extra afbeelding



Specificaties

designation	LR202-2RSR
Boring diameter (mm)	40
Buitendiameter (mm)	15
Breedte (mm)	11
Gewicht (kg)	0.07
Omschrijving (EN)	Track roller LR..-2RSR, single row, no plastic tyre
EAN-code	4012802826258
Merk	INA
Boring diameter (mm)	40
Buitendiameter (mm)	15
Breedte (mm)	11
Gewicht (kg)	0.07

Beschrijving

LR202-2RSR INA

Product URL

<https://aandrijftechniek.nl/product/lr202-2rsr-ina/>