

KR52-PP-A INA

SKU: INAKR52-PP-A

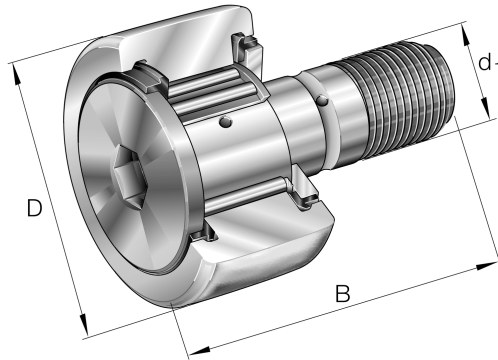

Specificaties

designation	KR52-PP-A
Boring diameter (mm)	52
Buitendiameter (mm)	20
Breedte (mm)	66
Gewicht (kg)	0.442
Omschrijving (EN)	Stud type track rollers KR..-PP, with axial guidance, plastic axial plain washers on both sides, optimized INA-profile
EAN-code	4012802428414
Merk	INA
Boring diameter (mm)	52
Buitendiameter (mm)	20
Breedte (mm)	66
Gewicht (kg)	0.442

Beschrijving

KR52-PP-A INA

Product URL

<https://aandrijftechniek.nl/product/kr52-pp-a-ina/>