

KR35-PP-A INA

SKU: INAKR35-PP-A

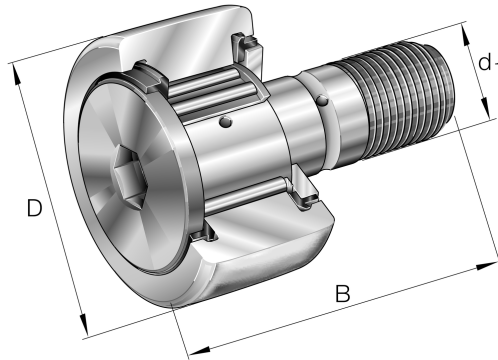

Specificaties

designation	KR35-PP-A
Boring diameter (mm)	35
Buitendiameter (mm)	16
Breedte (mm)	52
Gewicht (kg)	0.155
Omschrijving (EN)	Stud type track rollers KR..-PP, with axial guidance, plastic axial plain washers on both sides, optimized INA-profile
EAN-code	4012802428124
Merk	INA
Boring diameter (mm)	35
Buitendiameter (mm)	16
Breedte (mm)	52
Gewicht (kg)	0.155

Beschrijving

KR35-PP-A INA

Product URL

<https://aandrijftechniek.nl/product/kr35-pp-a-ina/>