

KR32-PP-A INA

SKU: INAKR32-PP-A

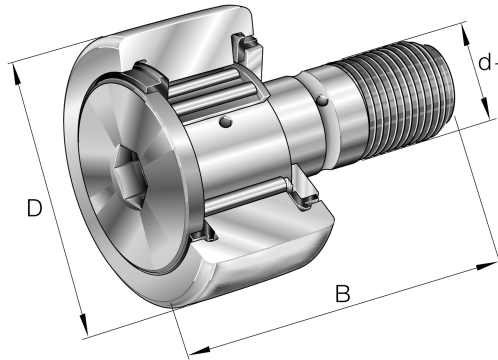

Specificaties

designation	KR32-PP-A
Boring diameter (mm)	32
Buitendiameter (mm)	12
Breedte (mm)	40
Gewicht (kg)	0.094
Omschrijving (EN)	Stud type track rollers KR..-PP, with axial guidance, plastic axial plain washers on both sides, optimized INA-profile
EAN-code	4012802427776
Merk	INA
Boring diameter (mm)	32
Buitendiameter (mm)	12
Breedte (mm)	40
Gewicht (kg)	0.094

Beschrijving

KR32-PP-A INA

Product URL

<https://aandrijftechniek.nl/product/kr32-pp-a-ina/>