

IR95X110X35-XL INA

SKU: INAIR95X110X35

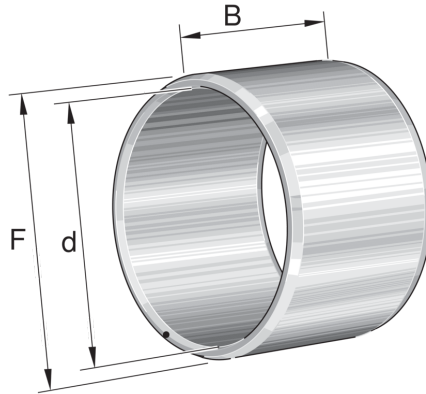

Specificaties

designation	IR95X110X35-XL
Boring diameter (mm)	95
Buitendiameter (mm)	110
Breedte (mm)	35
Eenheden	pc
Gewicht (kg)	0.645
Omschrijving (EN)	Inner ring IR..-XL, cylindrical
EAN-code	4012802692556
Merk	INA
Boring diameter (mm)	95
Buitendiameter (mm)	110
Breedte (mm)	35
Gewicht (kg)	0.645

Beschrijving

IR95X110X35-XL INA Needle roller bearing components

Product URL

<https://aandrijftechniek.nl/product/ir95x110x35-xl-ina/>