

IR70X80X30-XL INA

SKU: INAIR70X80X30

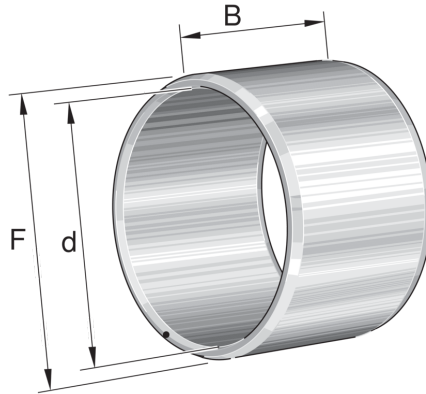

Specificaties

designation	IR70X80X30-XL
Boring diameter (mm)	70
Buitendiameter (mm)	80
Breedte (mm)	30
Eenheden	pc
Gewicht (kg)	0.268
Omschrijving (EN)	Inner ring IR..-XL, cylindrical
EAN-code	4012802044737
Merk	INA
Boring diameter (mm)	70
Buitendiameter (mm)	80
Breedte (mm)	30
Gewicht (kg)	0.268

Beschrijving

IR70X80X30-XL INA Needle roller bearing components

Product URL

<https://aandrijftechniek.nl/product/ir70x80x30-xl-ina/>