

IR32X37X20-XL INA

SKU: INAIR32X37X20

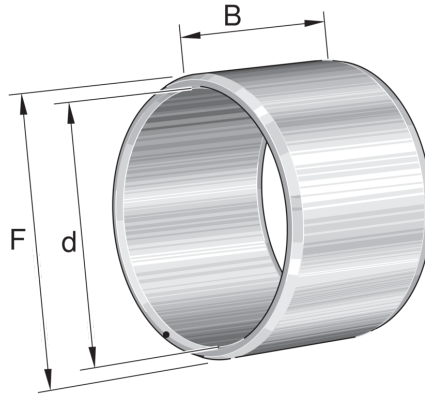

Specificaties

designation	IR32X37X20-XL
Boring diameter (mm)	32
Buitendiameter (mm)	37
Breedte (mm)	20
Eenheden	pc
Gewicht (kg)	0.041
Omschrijving (EN)	Inner ring IR..-XL, cylindrical
EAN-code	4012802712100
Merk	INA
Boring diameter (mm)	32
Buitendiameter (mm)	37
Breedte (mm)	20
Gewicht (kg)	0.041

Beschrijving

IR32X37X20-XL INA Needle roller bearing components

Product URL

<https://aandrijftechniek.nl/product/ir32x37x20-xl-ina/>