

IR30X35X16-XL INA

SKU: INAIR30X35X16

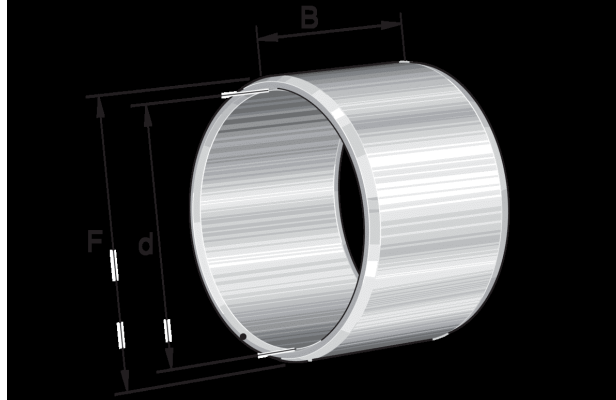

Specificaties

designation	IR30X35X16-XL
Boring diameter (mm)	30
Buitendiameter (mm)	35
Breedte (mm)	16
Eenheden	pc
Gewicht (kg)	0.0307
Omschrijving (EN)	Inner ring IR..-XL, cylindrical
EAN-code	4054369079784
Merk	INA
Boring diameter (mm)	30
Buitendiameter (mm)	35
Breedte (mm)	16
Gewicht (kg)	0.0307

Beschrijving

IR30X35X16-XL INA Needle roller bearing components

Product URL

<https://aandrijftechniek.nl/product/ir30x35x16-xl-ina/>