

HN1816 INA

SKU: INAHN1816

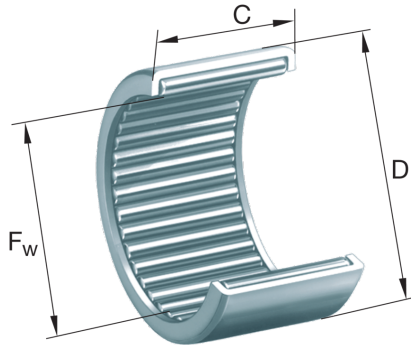

Extra afbeelding



Specificaties

designation	HN1816
Buitendiameter (mm)	24
Breedte (mm)	16
Gewicht (kg)	0.02
Omschrijving (EN)	Drawn cup needle roller bearings with open ends HN, full complement needle roller set
EAN-code	4054364228439
Merk	INA
Buitendiameter (mm)	24
Breedte (mm)	16
Gewicht (kg)	0.02

Beschrijving

HN1816 INA Drawn cup needle roller bearings

Product URL

<https://aandrijftechniek.nl/product/hn1816-ina/>