

HN1412 INA

SKU: INAHN1412

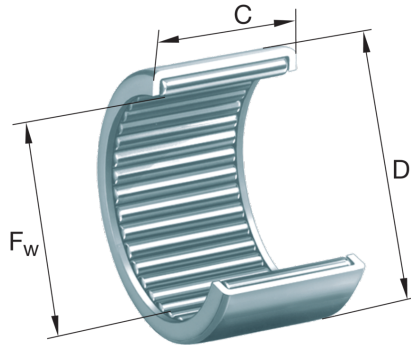

Extra afbeelding



Specificaties

designation	HN1412
Buitendiameter (mm)	20
Breedte (mm)	12
Gewicht (kg)	0.012
Omschrijving (EN)	Drawn cup needle roller bearings with open ends HN, full complement needle roller set
EAN-code	4012802168884
Merk	INA
Buitendiameter (mm)	20
Breedte (mm)	12
Gewicht (kg)	0.012

Beschrijving

HN1412 INA Drawn cup needle roller bearings

Product URL

<https://aandrijftechniek.nl/product/hn1412-ina/>