

HM3064 FAG

SKU: FAGHM3064

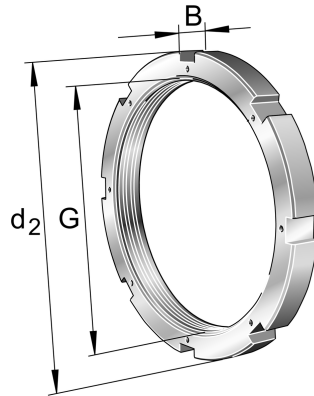

Extra afbeelding



Specificaties

designation	HM3064
Buitendiameter (mm)	380
Breedte (mm)	42
Gewicht (kg)	10.4
Omschrijving (EN)	Locknut HM
EAN-code	4012801218443
Merk	FAG
Buitendiameter (mm)	380
Breedte (mm)	42
Gewicht (kg)	10.4

Beschrijving

HM3064 FAG Locknuts and washers

Product URL

<https://aandrijftechniek.nl/product/hm3064-fag/>