

HK5025-AS1 INA

SKU: INAHK5025-AS1

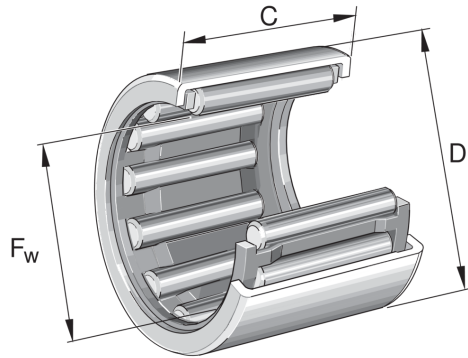

Extra afbeelding



Specificaties

designation	HK5025-AS1
Buitendiameter (mm)	58
Breedte (mm)	25
Gewicht (kg)	0.09
Omschrijving (EN)	Drawn cup needle roller bearing open end HK..-AS1, single row, with cage
EAN-code	4054364525965
Merk	INA
Buitendiameter (mm)	58
Breedte (mm)	25
Gewicht (kg)	0.09

Beschrijving

HK5025-AS1 INA Drawn cup needle roller bearings

Product URL

<https://aandrijftechniek.nl/product/hk5025-as1-ina/>