

HK4016-B INA

SKU: INAHK4016-B

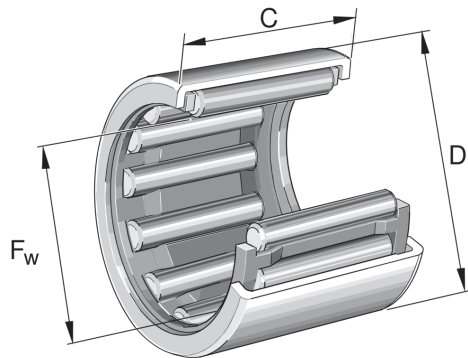

Specificaties

designation	HK4016-B
Buitendiameter (mm)	47
Breedte (mm)	16
Gewicht (kg)	0.0394
Omschrijving (EN)	Drawn cup needle roller bearings with open ends HK, to DIN 618/ISO 3245
EAN-code	4047643181495
Merk	INA
Buitendiameter (mm)	47
Breedte (mm)	16
Gewicht (kg)	0.0394

Beschrijving

HK4016-B INA Drawn cup needle roller bearings

Product URL

<https://aandrijftechniek.nl/product/hk4016-b-ina/>