

HK2512-AS1-B INA

SKU: INAHK2512-AS1-B

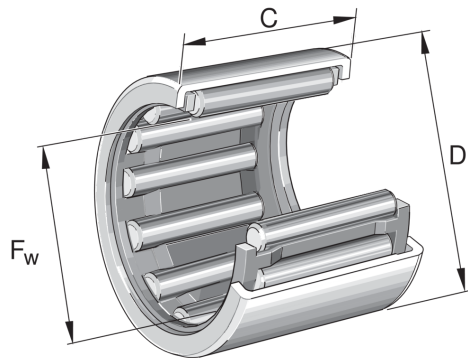

Specificaties

designation	HK2512-AS1-B
Buitendiameter (mm)	32
Breedte (mm)	12
Gewicht (kg)	0.02
Omschrijving (EN)	Drawn cup needle roller bearing open end HK...-AS1-B, single row, with cage
EAN-code	4012802430455
Merk	INA
Buitendiameter (mm)	32
Breedte (mm)	12
Gewicht (kg)	0.02

Beschrijving

HK2512-AS1-B INA Drawn cup needle roller bearings

Product URL

<https://aandrijftechniek.nl/product/hk2512-as1-b-ina/>