

HK2012-AS1-B INA

SKU: INAHK2012-AS1-B

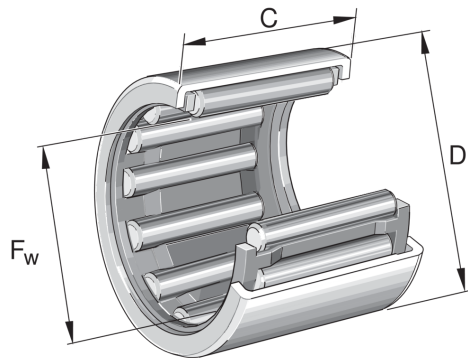

Extra afbeelding



Specificaties

designation	HK2012-AS1-B
Buitendiameter (mm)	26
Breedte (mm)	12
Gewicht (kg)	0.013372
Omschrijving (EN)	Drawn cup needle roller bearing open end HK..-AS1-B, single row, with cage
EAN-code	4012802422184
Merk	INA
Buitendiameter (mm)	26
Breedte (mm)	12
Gewicht (kg)	0.013372

Beschrijving

HK2012-AS1-B INA Drawn cup needle roller bearings

Product URL

<https://aandrijftechniek.nl/product/hk2012-as1-b-ina/>