

HK1210-B-L271 INA

SKU: INAHK1210-B-L271

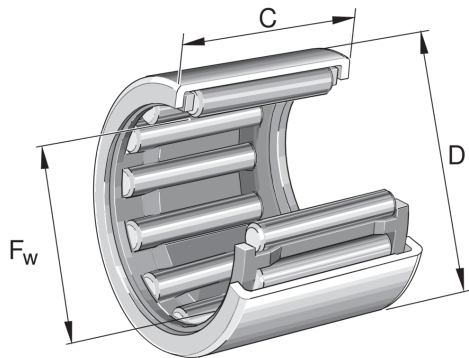

Extra afbeelding



Specificaties

designation	HK1210-B-L271
Buitendiameter (mm)	16
Breedte (mm)	10
Gewicht (kg)	0.0046
Omschrijving (EN)	Drawn cup needle roller bearings with open ends HK, to DIN 618/ISO 3245
EAN-code	4047643177436
Merk	INA
Buitendiameter (mm)	16
Breedte (mm)	10
Gewicht (kg)	0.0046

Beschrijving

HK1210-B-L271 INA Drawn cup needle roller bearings

Product URL

<https://aandrijftechniek.nl/product/hk1210-b-1271-ina/>