

HK1010-B-L025 INA

SKU: INAHK1010-B-L025

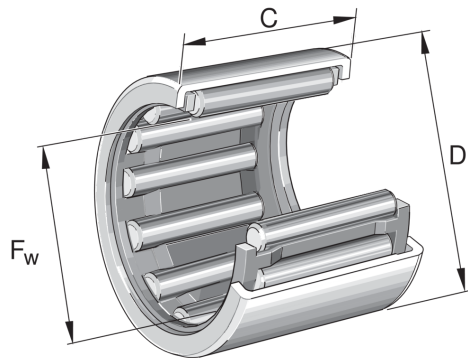

Extra afbeelding



Specificaties

designation	HK1010-B-L025
Buitendiameter (mm)	14
Breedte (mm)	10
Gewicht (kg)	0.00372
Omschrijving (EN)	Drawn cup needle roller bearings with open ends HK, to DIN 618/ISO 3245
EAN-code	4054362388944
Merk	INA
Buitendiameter (mm)	14
Breedte (mm)	10
Gewicht (kg)	0.00372

Beschrijving

HK1010-B-L025 INA Drawn cup needle roller bearings

Product URL

<https://aandrijftechniek.nl/product/hk1010-b-1025-ina/>