

H320 FAG

SKU: FAGH320

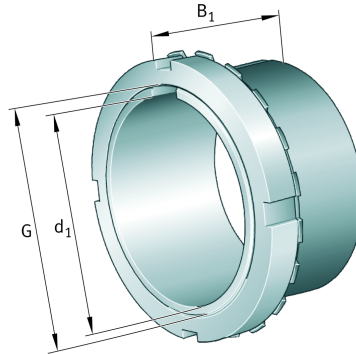

Extra afbeelding



Specificaties

designation	H320
Boring diameter (mm)	90
Eenheden	pc
Gewicht (kg)	1.694
Omschrijving (EN)	Adapter sleeve H, accessory rolling bearing, complete, mechanical, FP
EAN-code	4012801217262
Merk	FAG
Boring diameter (mm)	90
Gewicht (kg)	1.694

Beschrijving

H320 FAG Adapter and withdrawal sleeves

Product URL

<https://aandrijftechniek.nl/product/h320-fag/>