

H306 FAG

SKU: FAGH306

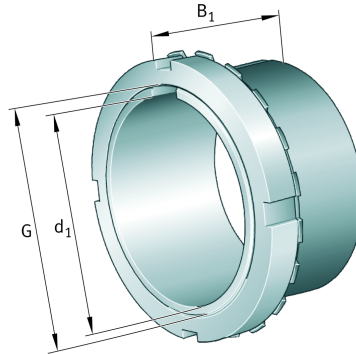

Extra afbeelding



Specificaties

designation	H306
Boring diameter (mm)	25
Eenheden	pc
Gewicht (kg)	0.106
Omschrijving (EN)	Adapter sleeve H, accessory rolling bearing, complete, mechanical, FP
EAN-code	4012801052184
Merk	FAG
Boring diameter (mm)	25
Gewicht (kg)	0.106

Beschrijving

H306 FAG Adapter and withdrawal sleeves

Product URL

<https://aandrijftechniek.nl/product/h306-fag/>