

H305 FAG

SKU: FAGH305

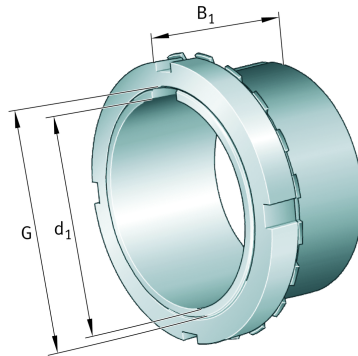

Extra afbeelding



Specificaties

designation	H305
Boring diameter (mm)	20
Eenheden	pc
Gewicht (kg)	0.074
Omschrijving (EN)	Adapter sleeve H, accessory rolling bearing, complete, mechanical, FP
EAN-code	4012801170604
Merk	FAG
Boring diameter (mm)	20
Gewicht (kg)	0.074

Beschrijving

H305 FAG Adapter and withdrawal sleeves

Product URL

<https://aandrijftechniek.nl/product/h305-fag/>