

AH3032 FAG

SKU: FAGAH3032

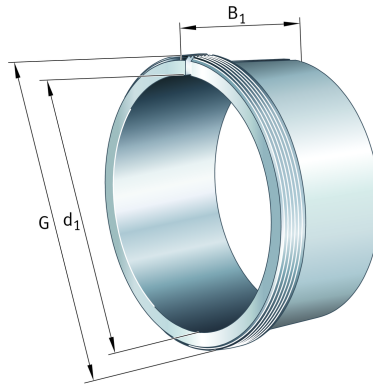

Extra afbeelding



Specificaties

designation	AH3032
Boring diameter (mm)	150
Breedte (mm)	77
Eenheden	pc
Gewicht (kg)	2.238
Omschrijving (EN)	Withdrawal sleeve AH, accessory rolling bearing, mechanical, finished part
EAN-code	4012801208611
Merk	FAG
Boring diameter (mm)	150
Breedte (mm)	77
Gewicht (kg)	2.238

Beschrijving

AH3032 FAG Adapter and withdrawal sleeves

Product URL

<https://aandrijftechniek.nl/product/ah3032-fag/>