

1222-K-M-C3 FAG

SKU: FAG1222-K-M-C3

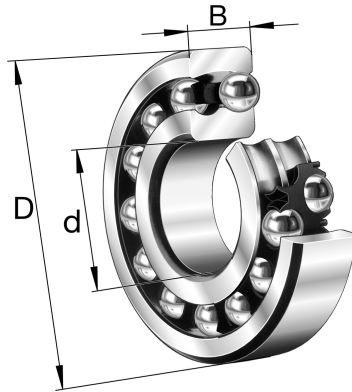

Extra afbeelding



Specificaties

designation	1222-K-M-C3
Boring diameter (mm)	110
Buitendiameter (mm)	200
Breedte (mm)	38
Gewicht (kg)	5.27
Omschrijving (EN)	Self-aligning ball bearing 12..-K-M, tapered bore taper 1:12, solid brass cage
EAN-code	4012801184229
Merk	FAG
category1	Self aligning ball bearing
endCategory	Self aligning ball bearing
Boring diameter (mm)	110
Buitendiameter (mm)	200
Breedte (mm)	38
Gewicht (kg)	5.27

Beschrijving

1222-K-M-C3 FAG Self aligning ball bearing

Product URL

<https://aandrijftechniek.nl/product/1222-k-m-c3-fag/>